

SPECIFICATION FOR LCD MODULE

MODULE NO: YB-TG480128S01A-C-A0

Doc.Version:00

Customer Approval:

<input type="checkbox"/> Accept	<input type="checkbox"/> Reject
---------------------------------	---------------------------------

YEEBO	NAME	SIGNATURE	DATE
Prepare	Electronic Engineer	张盛	2020/3/24
Check	Mechanical Engineer	张盛	2020/3/24
Verify			
Approval		孙亚南	2020/3/25

APPROVAL FOR SPECIFICATIONS ONLY

APPROVAL FOR SPECIFICATIONS AND SAMPLE

WIMRD005-02-D

1. Revision History

Sample Version	DOC. Version	DATE	DESCRIPTION		CHANGED BY
A0	00	2020-03-24	SPEC ONLY	First issue	ZS

2. Table of Contents:

NO	CONTENTS	PAGE
1	Revision History	1
2	Table of Contents	2
3	Module Numbering System	3
4	General Specification	4
5	LCM drawing	5
6	Electrical Characteristics	6
7	Optical Characteristics	9
8	Interface Pin Assignment	11
9	Block Diagram	12
10	Backlight	13
11	Standard Specification for Reliability	14
12	Specification of Quality Assurance	16
13	Handling Precaution	24
14	Guarantee	24

3. Module Numbering System:

(Example)

YB-TG240320S01D-T-A0

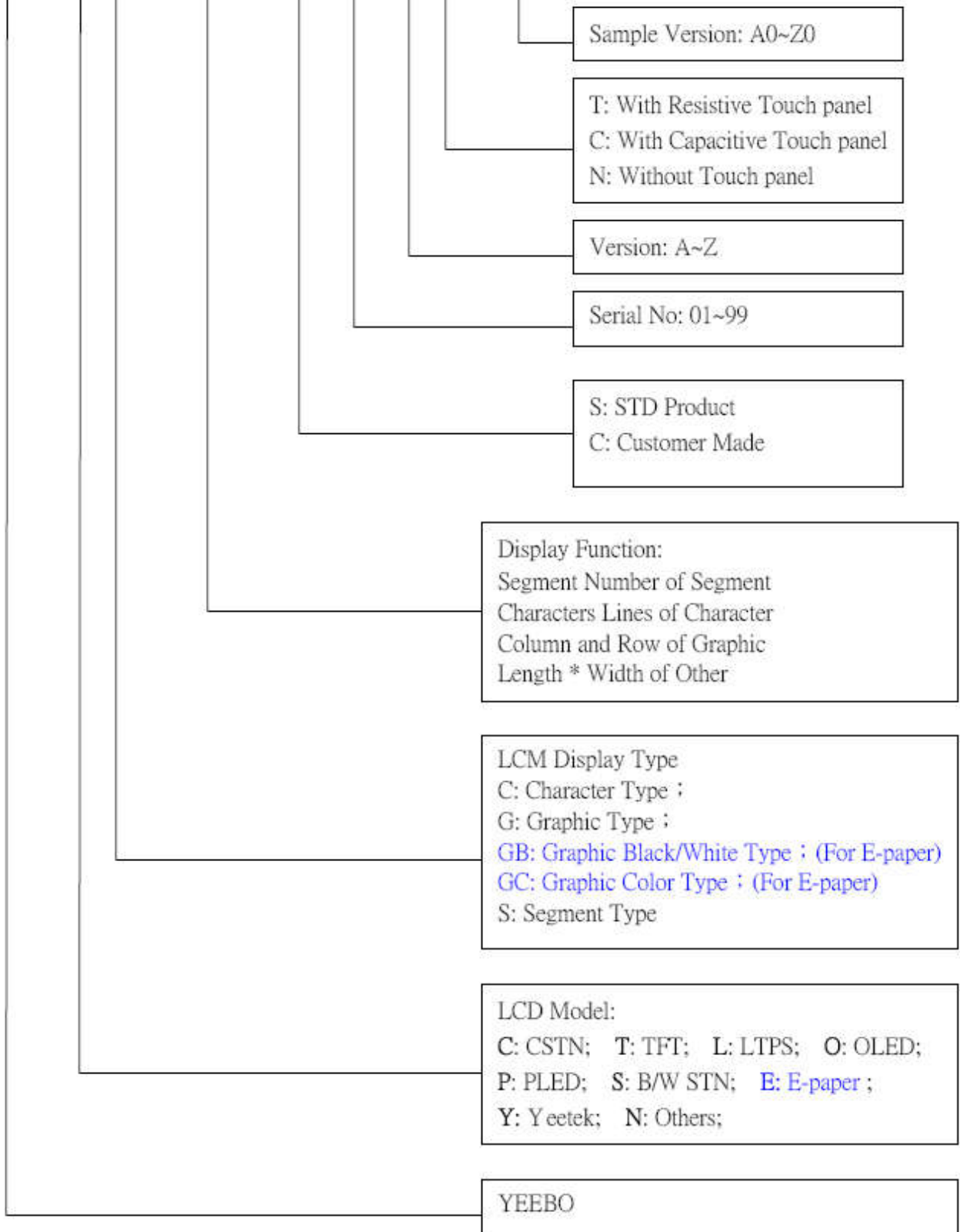

4. General Specification:

ITEM	CONTENTS
Module Size	105.9(W) *39.2 (H) * 3.8(T) mm
Display Size(Diagonal)	3.9 inch
Structure	OGS+TFT
Display Format	480(RGB)* 128 Pixels
Dots Pitch	0.198*0.198 mm
LCD Type	TFT (16.7M)/ Transmissive / Normal Black
Viewing Angle	Free
Controller IC	SC7283
TP IC	ILI2117A
Interface	I ² C
Hardness	≥6H
Weight	TBD

5. LCM drawing:

Count drawing & Spec.	revision record during discussion with customer
Rec.	Revision content description
#1	FIRST ISSUE
Date	2020-03-24

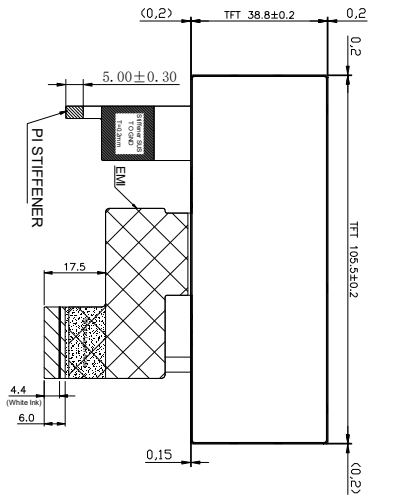
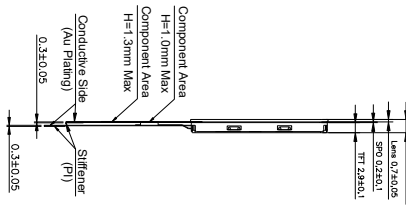
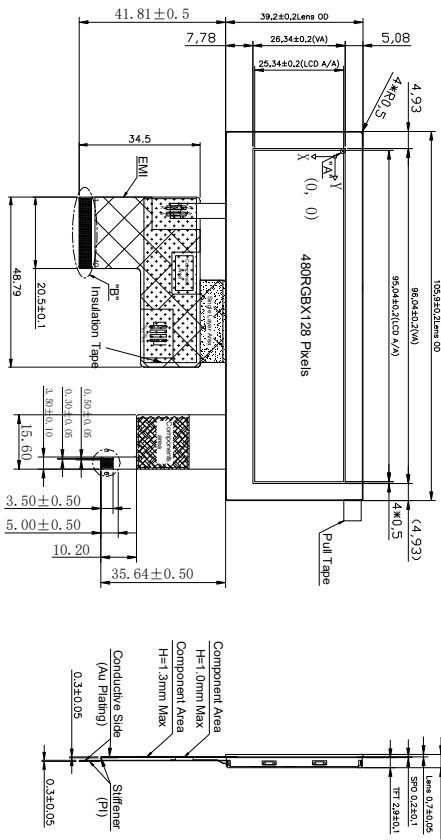

- Specification:**
1. Display mode: 3.9" TFT (16.7M) / Transmissive / Normal Black
 2. Viewing Direction: Free
 3. Controller IC: SC7283 or Compatible
 4. Glass Type: OGS+TFT
 5. TP Drive IC: IS-IL12117A
 6. Hardness: >6H, Linearity: =3.0%
 7. Interface: IIC
 8. Operating temperature: -20°C to +70°C
 9. Storage temperature: -30°C to +80°C
 10. Unspecified tolerance: ±0.30mm.
 10. ROHS compliant

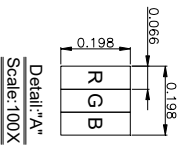

Detail "A"
Scale: 100X

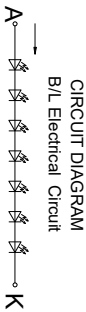

CIRCUIT DIAGRAM
B/L Electrical Circuit

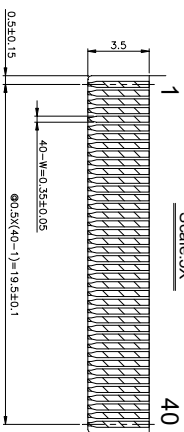

Detail "B"
Scale: 5X

TP PIN ASSIGNMENT	No.	Symbol
VDD	1	VDD
RESET	2	RESET
INT	3	INT
SCL	4	SCL
SDA	5	SDA
GND	6	GND

NO.	Symbol	LEDK	LEDK	GND	VDD	R0	R1	R2	R3	R4	R5	R6	R7	G0	G1	G2	G3	G4	G5	G6	G7	B0	B1	B2	B3	B4	B5	B6	B7	GND	DCLK	DSP	HSYNC	VSYNC	DE	NC	GND	NC/XR	NC/YD	NC/XL	NC/YU					
1	LEDK																																													

		MOD. Name YB-TG480128S01A-C-A		DESIGNED 		CHECKED 		VERIFIED 		APPROVED 		FILE NAME Count Dwg.	
UNIT	SIZE	SCALE											
mm	A4	N-T-S											

6. Electrical Characteristics

6-1 Absolute Maximum Ratings

(Ta=25°C VSS=0V)

Item	Symbol	Min.	Type	Max.	Unit	Remark
Power Supply voltage	VDD	-0.5		+4.0	Volt	
Operating Temperature	Topr	-20	-	70	°C	
Storage Temperature	Tstg	-30	-	80	°C	

Note1: Absolute maximum rating is the limit value beyond which the IC may be broken.
They do not assure operations.

6-1-2 TP Absolute Maximum Ratings

(Ta=25°C VSS=0V)

Item	Symbol	Min	Typ	Max	Unit
System power supply voltage	VDD			3.6	V
High voltage power supply	VPVDD_CP		3.6	3.7	V
Analog input voltage	V _{INANA}			VDD	V
Digital input voltage	V _{INDIG}			5	V
Storage temperature	T _{STG}	-40		150	°C

Notes: Stresses above those listed in Absolute Maximum Ratings may cause permanent damage to the device. This is a stress rating only and does not imply functional operation of the device. Exposure to absolute maximum ratings for extended periods may affect device reliability.

6-2 Operating Conditions

(Ta=25°C)

Item	Symbol	Condition	Min.	Typ.	Max.	Unit
Power Supply voltage	VDD	-	3.0	3.3	3.6	Volt
Level Input Voltage	V _{IH}	-	0.7*VDD	-	VDD	Volt
	V _{IL}	-	GND		0.3*VDD	Volt
Power Supply Current for LCM	IDD	-	-	TBD	-	mA

Note1:GND=0V

6-3 Timing Characteristics

6-3-1 Clock and data input timing diagram

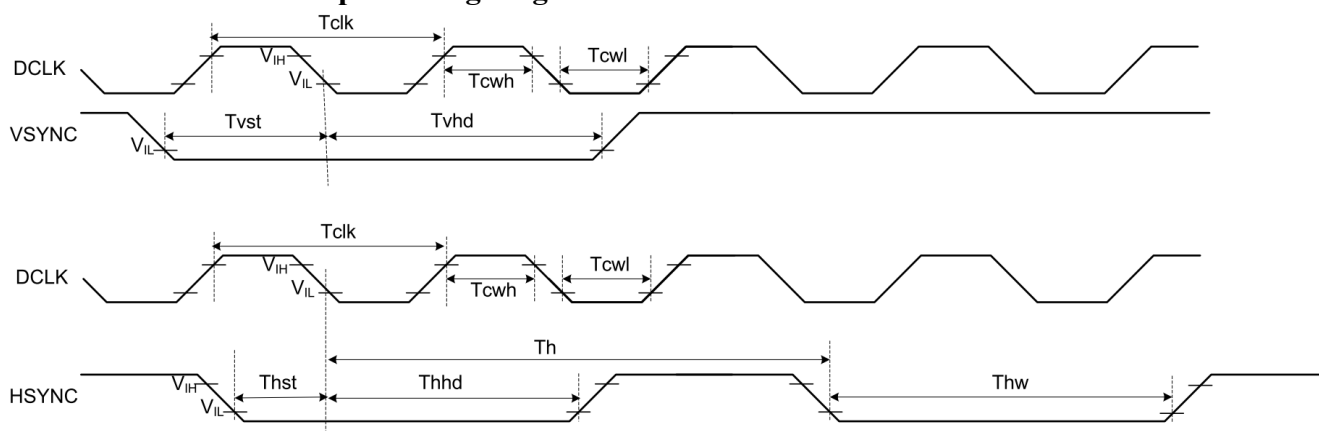

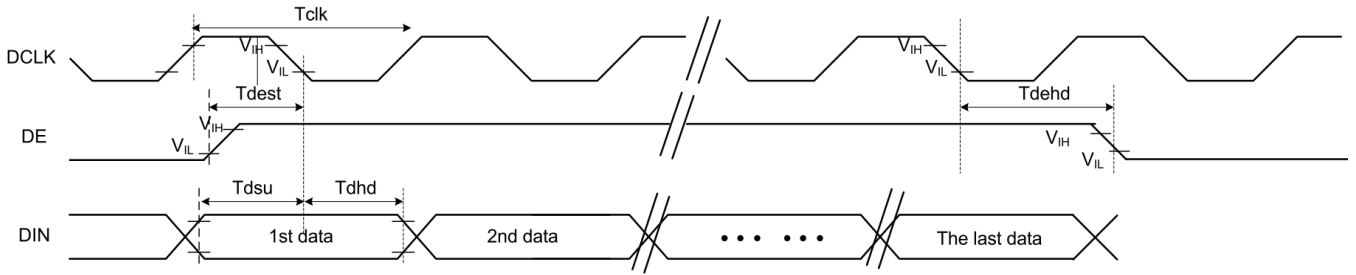

6-3-2 TP I²C interface

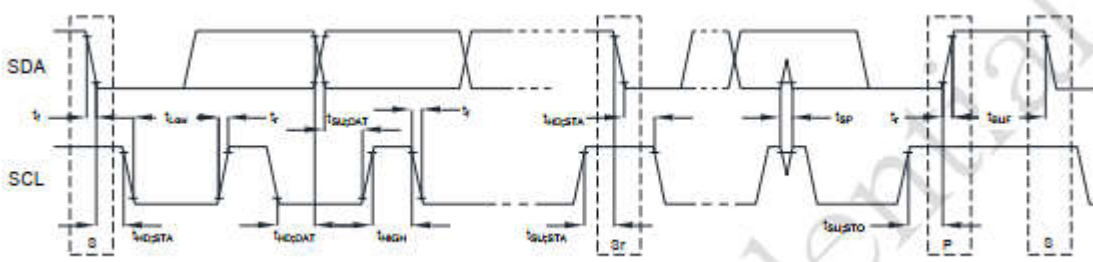

Symbol	Parameter	100KHz			400KHz		
		Min	Max	Unit	Min	Max	Unit
f_{SCL}	SCL clock frequency	0	100	kHz	0	400	KHz
$t_{HD,STA}$	Hold time (repeated) START condition. After this period, the first clock pulse is generated	4.0	-	μs	0.6	-	μs
t_{LOW}	LOW period of the SCL clock	4.7	-	μs	1.3	-	μs
t_{HIGH}	HIGH period of the SCL clock	4.0	-	μs	0.6	-	μs
$t_{SU,STA}$	Set-up time for a repeated START condition	4.7	-	μs	0.6	-	μs
$t_{HD,DAT}$	Data hold time	0	3.45	μs	0	0.9	μs
$t_{SU,DAT}$	Data set-up time	250	-	ns	100	-	ns
t_r	Rise time of both SDA and SCL signals	-	1000	ns	-	300	ns
t_f	Fall time of both SDA and SCL signals	-	300	ns	-	300	ns
$t_{SU,STO}$	Set-up time for STOP condition	4.0	-	μs	0.6	-	μs
t_{BUF}	Bus free time between a STOP and START condition	4.7	-	μs	1.3	-	μs

6-3-3RGB input timing table

6-3-3-1 Parallel 24-bit RGB timing table

480RGB X 272 Resolution Timing Table							
Item	Symbol	Min.	Typ.	Max.	Unit	Remark	
DCLK Frequency	Fclk	8	9	12	MHz		
DCLK Period	Tclk	83	111	125	ns		
HSYNC	Period Time	Th	485	531	598	DCLK	
	Display Period	Thdisp		480		DCLK	
	Back Porch	Thbp	3	43	43	DCLK	By H_BLANKING setting
	Front Porch	Thfp	2	8	75	DCLK	
	Pulse Width	Thw	2	4	43	DCLK	
VSYNC	Period Time	Tv	276	292	321	HSYNC	
	Display Period	Tvdisp		272		HSYNC	
	Back Porch	Tvbp	2	12	12	HSYNC	By V_BLANKING setting
	Front Porch	Tvfp	2	8	37	HSYNC	
	Pulse Width	Tvw	2	4	12	HSYNC	

Note: It is necessary to keep Tvbp =12 and Thbp =43 in sync mode. DE mode is unnecessary to keep it.

6-3-4 DE mode timing diagram

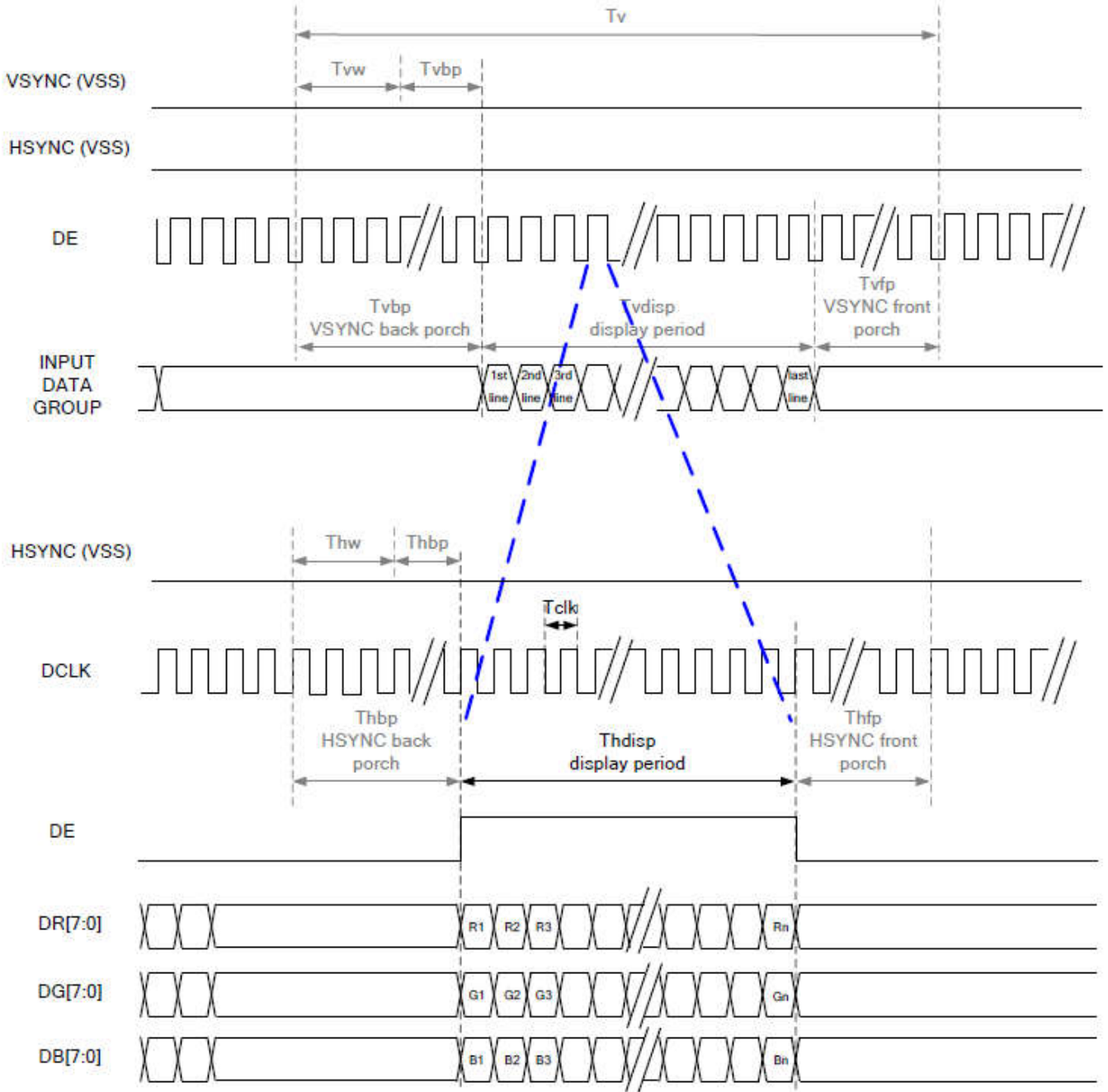

RGB Mode Selection Table	DCLK	HSYNC	VSYNC	DE
SYNC - DE Mode	Input	Input	Input	Input
SYNC Mode	Input	Input	Input	GND
DE Mode	Input	GND	GND	Input

7. Optical Characteristics:

Item	Symbol	Conditions	Specifications			Unit	Note	
			Min	Typ	Max			
Transmittance	T(%)	-	-	6.6	-	-	-	
Contrast Ratio	CR	$\Theta = 0$ Normal Viewing angle	640	800	-		(1) (2)	
Response time	TR+TF	-	-	30	40	ms	(1) (3)	
Viewing angle	Hor.	Θ_{x+}	CR ≥ 10	-	80	-	deg.	-
		Θ_{x-}		-	80	-		
	Ver.	Θ_{y+}		-	80	-		
		Θ_{y-}		-	80	-		

Measuring Condition

1. Measuring surrounding: dark room
2. Ambient temperature: $25 \pm 2^\circ\text{C}$
3. 30 min. Warm-up time.

Color of CIE Coordinate:

Item		Symbol	Condition	Min.	Typ.	Max.
Chromaticity Coordinates (Transmissive)	Red	x	$\theta = 0^\circ$ Backlight Color Degree	TBD	0.613	TBD
		y		TBD	0.352	TBD
	Green	x		TBD	0.387	TBD
		y		TBD	0.560	TBD
	Blue	x		TBD	0.145	TBD
		y		TBD	0.123	TBD
	White	x		TBD	0.340	TBD
		y		TBD	0.360	TBD

Note (1) Definition of Viewing Angle :

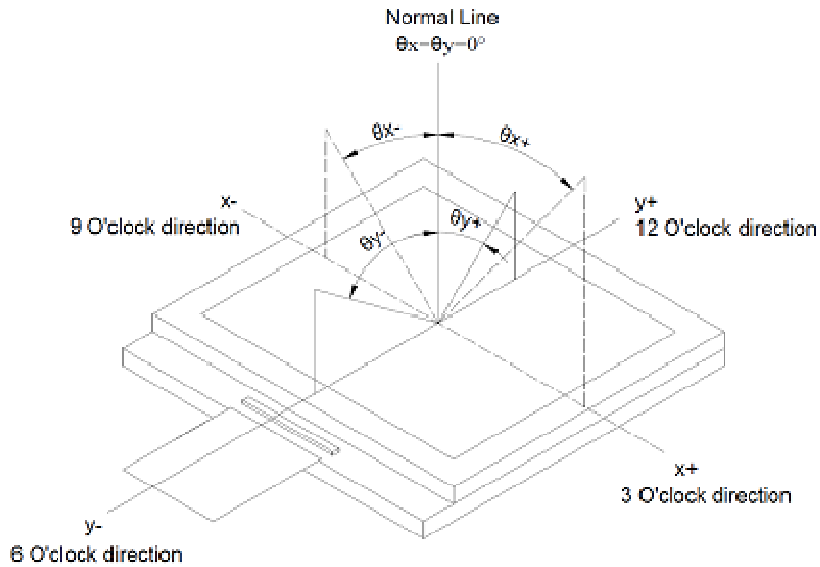

Note (2) Definition of Contrast Ratio(CR) :
measured at the center point of panel

$$\text{Contrast ratio (CR)} = \frac{\text{Photo detector output when LCD is at "White" state}}{\text{Photo detector output when LCD is at "Black" state}}$$

Note (3) Definition of Response Time : Sum of TR and TF

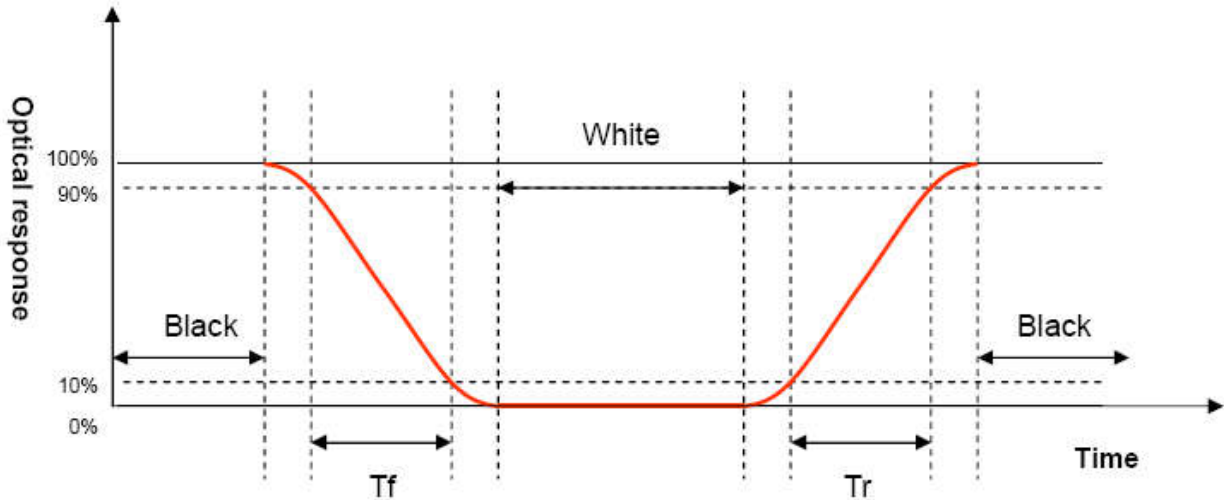

8. Interface Pin Assignment:

8-1 LCM FPC interface

No.	Symbol	Function
1	LEDK	Cathode of LED backlight
2	LEDA	Anode of LED backlight
3	GND	GND Power ground
4	VDD	Power voltage.
5~12	R0~ R7	Digital data input.R0(LSB),R7(MSB)
13~20	G0~ G7	Digital data input.G0(LSB),G7(MSB)
21~28	B0~ B7	Digital data input.B0(LSB),B7(MSB)
29	GND	Power ground
30	DCLK	Data clock signal input
31	DISP	Display on/off mode control. (a) DISP=L, standby mode. (b) DISP=H, normal display mode.
32	HSYNC	Horizontal sync signal input
33	VSYNC	Vertical sync signal input
34	DE	Data enable input.
35	NC	No connection
36	GND	Power ground
37	NC/XR	No connection, reserve for TP interface.
38	NC/YD	No connection, reserve for TP interface.
39	NC/XL	No connection, reserve for TP interface.
40	NC/YU	No connection, reserve for TP interface.

8-2 TP FPC Interface

No.	Symbol	I/O	Function
1	VDD	P	Power Supply
2	RST	I	System reset signal input, active low
3	INT	O	Indicate coordinate data ready
4	SCL	I/O	I2C Serial Clock
5	SDA	I/O	I2C Serial Data
6	GND		Groud

9. Block Diagram:

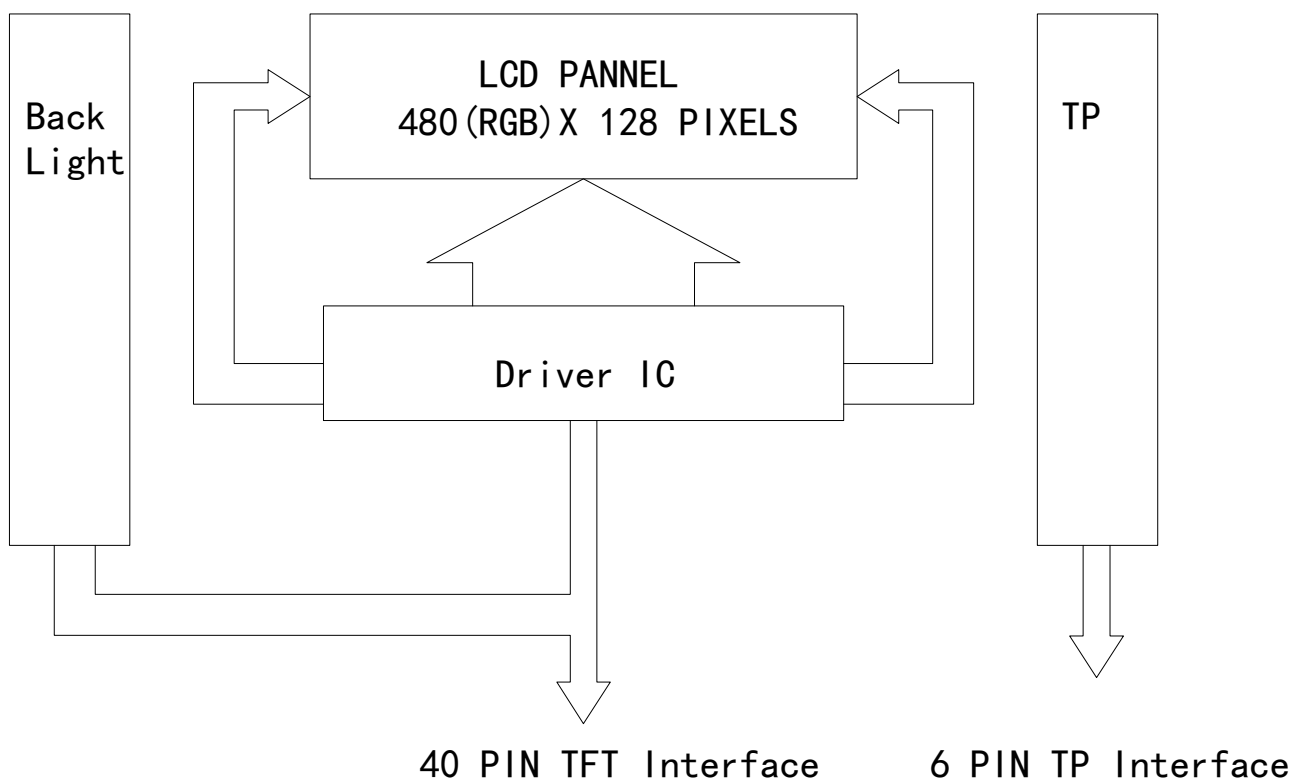

10. Backlight:

1. Standard Lamp Styles (Edge Lighting Type):

The LED chips are distributed over the edge light area of the illumination unit, which gives the less power consumption:

2. The Main Advantages of the LED Backlight are as following:

2.1 The brightness of the backlight can simply be adjusted.

By a resistor or a potentiometer.

3. Data About LED Backlight:

($T_a=25^\circ$)

PARAMETER	Sym.	Min.	Typ.	Max.	Unit	Test Condition	Note
Supply Current	I	-	20	-	mA	-	
Supply Voltage	V	18.9	22.4	24.5	V	If=20mA	
Luminous Intensity for LCM	I_v	320	400	-	Cd/m ²	If=20mA	2
Uniformity for LCM	-	70	-	-	%		3
Life Time	-	20000	-	-	Hr.		4
Color	White						

NOTE:

1. Backlight Only

2. Average Luminous Intensity of P1-P9

3. Uniformity = Min/Max * 100%

4. LED life time defined as follows: The final brightness is at 50% of original brightness

Measured Method: (X*Y: Light Area)

Internal Circuit Diagram

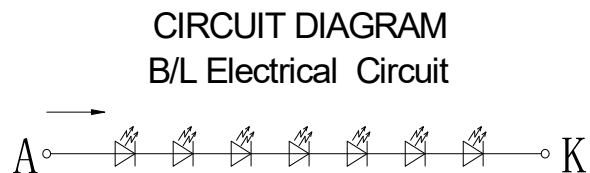
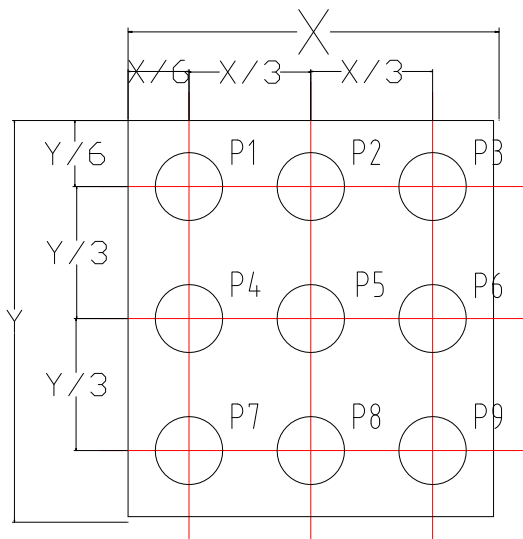

(Effective spatial Distribution)

Using aperture of 1°, distance 50cm.

11. Standard Specification for Reliability:

11-1. Standard Specifications for Reliability of LCD Module

No	Item	Description
01	High temperature operation	The sample should be allowed to stand at 70°C for 120 hours under driving condition and then returning it to normal temperature condition, and allowing it stand for 2 hours.
02	Low temperature operation	The sample should be allowed to stand at -20°C for 120 hours under driving condition and then returning it to normal temperature condition, and allowing it stand for 2 hours.
03	High temperature storage	The sample should be allowed to stand at 80°C for 240 hours under no-load condition, and then returning it to normal temperature condition, and allowing it stand for 2 hours.
04	Low temperature storage	The sample should be allowed to stand at -30°C for 240 hours under no-load condition, then returning it to normal temperature condition, and allowing it stand for 2 hours.
05	Moisture storage	The sample should be allowed to stand at 60°C,90%RH MAX for 240 hours under no-load condition, then taking it out and drying it at normal temperature for 2 hours.
06	Thermal shock storage	The sample should be allowed to stand the following 10 cycles : -30°C for 30 minutes → normal temperature for 5 minutes → +80°C for 30 minutes → normal temperature for 5 minutes, as one cycle.
07	Packing vibration	Frequency range : 10Hz ~ 55Hz Amplitude of vibration : 1.5mm Sweep time: 12 min X,Y,Z 2 hours for each direction.
08	Packing drop test	According to ISTA 1A 2001.
09	Electrical Static Discharge	Air: ±6KV 150pF/330Ω 5 times
		Contact: ±4KV 150pF/330Ω 5 time

*Sample size for each test item is 3~5pcs

11 - 2. Testing Conditions and Inspection Criteria

For the final test the testing sample must be stored at room temperature for 24 hours, after the tests listed in Table 11.2, Standard specifications for Reliability have been executed in order to ensure stability.

No	Item	Test Model	In section Criteria
01	Current Consumption	Refer To Specification	The current consumption should conform to the product specification.
02	Contrast	Refer To Specification	After the tests have been executed, the contrast must be larger than half of its initial value prior to the tests.
03	Appearance	Visual inspection	Defect free.

11- 3. MTBF

MTBF	Functions, performance, appearance, etc. shall be free from remarkable deterioration within 50,000 hours under ordinary operating and storage conditions room temperature ($25\pm 5^{\circ}\text{C}$), normal humidity ($50\pm 10\%$ RH), and in area not exposed to direct sun light.
------	---

12. Specification of Quality Assurance:

12-1. Purpose

This standard for Quality Assurance should affirm the quality of LCD module products to supply to purchaser by YEEBO CORPORATION (Supplier).

12-2. Standard for Quality Test

a. Inspection:

Before delivering, the supplier should take the following tests, and affirm the quality of product.

b. Electro-Optical Characteristics:

According to the individual specification to test the product.

c. Test of Appearance Characteristics:

According to the individual specification to test the product.

d. Test of Reliability Characteristics:

According to the definition of reliability on the specification for testing products.

e. Delivery Test:

Before delivering, the supplier should take the delivery test.

(i) Test method: According to **ISO2859-1**.General Inspection Level II take a single time.

(ii) The defects classify of AQL as following:

Major defect: AQL = 0.65

Minor defect: AQL = 2.5

Total defects: AQL = 2.5

12-3. Non- conforming Analysis & Deal With Manners

a. Non- conforming Analysis:

(i) Purchaser should supply the detail data of non- conforming sample and the non-conforming.

(ii) After accepting the detail data from purchaser, the analysis of non- conforming should be finished in two weeks.

(iii) If supplier can not finish analysis on time, must announce purchaser before 3 days.

b. Disposition of non- conforming:

(i) If find any product defect of supplier during assembly time, supplier must change the good product for every defect after recognition.

(ii) Both supplier and customer should analyze the reason and discuss the disposition of non- conforming when the reason of nonconforming is not sure.

12-4. Agreement items

Both sides should discuss together when the following problems happen.

a. There is any problem of standard of quality assurance, and both sides should think that must be modified.

b. There is any argument item which does not record in the standard of quality assurance.

c. Any other special problem.

12-5. Standard of The Product Appearance Test

a. Manner of appearance test:

(i) The test must be under 20W × 2 or 40W fluorescent light, and the distance of view must be at 30±5cm.

(ii) When test the model of transmissive product must add the reflective plate.

(iii) The test direction is base on around 10° of vertical line.

(iiii) Temperature: 25±5°C Humidity: 60±10%RH

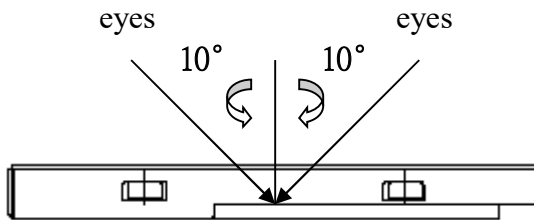

(iv) Definition of area:

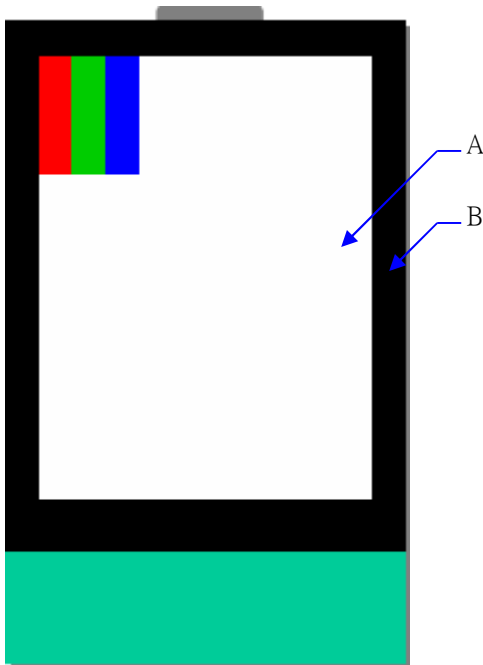

A. Area: Viewing area.

B. Area: Out of viewing area.

(Outside viewing area)

b. Basic principle:

(i) It will accord to the AQL when the standard can not be described.

(ii) The sample of the lowest acceptable quality level must be discussed by both supplier and customer when any dispute happened.

(iii) Must add new item on time when it is necessary.

c. Standard of inspection: (Unit: mm)

12-6. Inspection specification
Defect out of viewing area can be neglected.

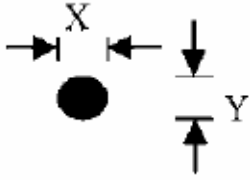
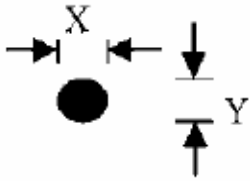
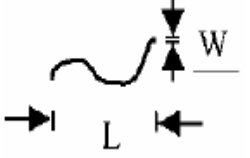
NO	Item	Criterion	AQL													
01	Electrical Testing	1.1 Missing vertical, horizontal segment, segment contrast defect. 1.2 Missing character, dot or icon. 1.3 Display malfunction. 1.4 No function or no display. 1.5 Current consumption exceeds product specifications. 1.6 LCD viewing angle defect. 1.7 Mixed product types. 1.8 Flicker	0.65													
02	Black or White spots or Bright spots or Color spots on LCD (Display only)	2.1 Dot dimension as below drawing: $\Phi = (X+Y) / 2$  <table border="1" data-bbox="758 772 1292 936"> <thead> <tr> <th>Size(mm)</th> <th>Acceptable Q'ty</th> </tr> </thead> <tbody> <tr> <td>$\Phi \leq 0.20$</td> <td>Accept no dense</td> </tr> <tr> <td>$0.20 < \Phi \leq 0.40$</td> <td>5</td> </tr> <tr> <td>$0.40 < \Phi$</td> <td>0</td> </tr> </tbody> </table> 2.2 Not visible through 5% ND filter * Densely spaced: No more than two spots within 3mm.	Size(mm)	Acceptable Q'ty	$\Phi \leq 0.20$	Accept no dense	$0.20 < \Phi \leq 0.40$	5	$0.40 < \Phi$	0	2.5					
Size(mm)	Acceptable Q'ty															
$\Phi \leq 0.20$	Accept no dense															
$0.20 < \Phi \leq 0.40$	5															
$0.40 < \Phi$	0															
03	LCD and Touch Panel black spots, white spots, contamination (non – display)	3.1 Round type: As following drawing $\Phi = (X+Y) / 2$  <table border="1" data-bbox="758 1198 1292 1361"> <thead> <tr> <th>Size(mm)</th> <th>Acceptable Q'ty</th> </tr> </thead> <tbody> <tr> <td>$\Phi \leq 0.20$</td> <td>Accept no dense</td> </tr> <tr> <td>$0.20 < \Phi \leq 0.40$</td> <td>5</td> </tr> <tr> <td>$0.40 < \Phi$</td> <td>0</td> </tr> </tbody> </table> * Densely spaced: No more than two spots within 3mm.	Size(mm)	Acceptable Q'ty	$\Phi \leq 0.20$	Accept no dense	$0.20 < \Phi \leq 0.40$	5	$0.40 < \Phi$	0	2.5					
		Size(mm)	Acceptable Q'ty													
$\Phi \leq 0.20$	Accept no dense															
$0.20 < \Phi \leq 0.40$	5															
$0.40 < \Phi$	0															
3.2 Line type: (As following drawing)  <table border="1" data-bbox="662 1556 1292 1921"> <thead> <tr> <th>Length(mm)</th> <th>Width(mm)</th> <th>Acceptable Q'ty</th> </tr> </thead> <tbody> <tr> <td>$L \leq 10$</td> <td>$W \leq 0.1$</td> <td>Accept no dense</td> </tr> <tr> <td>$L \leq 10.0$</td> <td>$0.1 < W \leq 0.25$</td> <td>4</td> </tr> <tr> <td>$L > 10$</td> <td>----</td> <td>Rejection</td> </tr> <tr> <td>----</td> <td>$0.25 < W$</td> <td>Rejection</td> </tr> </tbody> </table> * Densely spaced: No more than two lines within 3mm.	Length(mm)	Width(mm)	Acceptable Q'ty	$L \leq 10$	$W \leq 0.1$	Accept no dense	$L \leq 10.0$	$0.1 < W \leq 0.25$	4	$L > 10$	----	Rejection	----	$0.25 < W$	Rejection	2.5
Length(mm)	Width(mm)	Acceptable Q'ty														
$L \leq 10$	$W \leq 0.1$	Accept no dense														
$L \leq 10.0$	$0.1 < W \leq 0.25$	4														
$L > 10$	----	Rejection														
----	$0.25 < W$	Rejection														

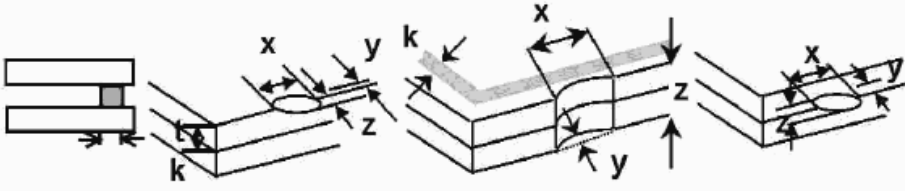
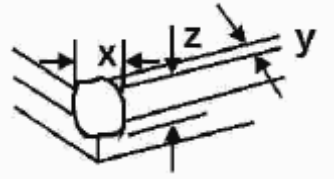
NO	Item	Criterion	AQL																		
04	Polarizer bubbles	<p>If bubbles are visible, judge using black spot specifications, not easy to find, must check in specify direction</p> <table border="1"> <thead> <tr> <th>Size Φ(mm)</th> <th>Acceptable Q'ty</th> </tr> </thead> <tbody> <tr> <td>$\Phi \leq 0.20$</td> <td>Accept no dense</td> </tr> <tr> <td>$0.20 < \Phi \leq 0.50$</td> <td>4</td> </tr> <tr> <td>$0.50 < \Phi \leq 1.00$</td> <td>3</td> </tr> <tr> <td>$1.00 < \Phi$</td> <td>0</td> </tr> <tr> <td>Total Q'ty</td> <td>4</td> </tr> </tbody> </table>	Size Φ (mm)	Acceptable Q'ty	$\Phi \leq 0.20$	Accept no dense	$0.20 < \Phi \leq 0.50$	4	$0.50 < \Phi \leq 1.00$	3	$1.00 < \Phi$	0	Total Q'ty	4	2.5						
Size Φ (mm)	Acceptable Q'ty																				
$\Phi \leq 0.20$	Accept no dense																				
$0.20 < \Phi \leq 0.50$	4																				
$0.50 < \Phi \leq 1.00$	3																				
$1.00 < \Phi$	0																				
Total Q'ty	4																				
05	Scratches	Follow NO.3 -2 Line Type.																			
06	Mura	Not visible through 5% ND filter in 50% gray.	2.5																		
07	Chipped glass	<p>Symbols: x: Chip length y: Chip width z: Chip thickness k: Seal width t: Glass thickness a: LCD side length L: Electrode pad length</p> <p>7.1 General glass chip: 7.1.1 Chip on panel surface and crack between panels:</p>  <table border="1"> <thead> <tr> <th>z: Chip thickness</th> <th>y: Chip width</th> <th>x: Chip length</th> </tr> </thead> <tbody> <tr> <td>$Z \leq 1/2t$</td> <td>Not over viewing area</td> <td>$x \leq 1/8a$</td> </tr> <tr> <td>$1/2t < z \leq 2t$</td> <td>Not exceed 1/3k</td> <td>$x \leq 1/8a$</td> </tr> </tbody> </table> <p>⊙ Unit: mm ⊙ If there are 2 or more chips, x is the total length of each chip</p> <p>7.1.2 Corner crack:</p>  <table border="1"> <thead> <tr> <th>z: Chip thickness</th> <th>y: Chip width</th> <th>x: Chip length</th> </tr> </thead> <tbody> <tr> <td>$Z \leq 1/2t$</td> <td>Not over viewing area</td> <td>$x \leq 1/8a$</td> </tr> <tr> <td>$1/2t < z \leq 2t$</td> <td>Not exceed 1/3k</td> <td>$x \leq 1/8a$</td> </tr> </tbody> </table> <p>⊙ Unit: mm ⊙ If there are 2 or more chips, x is the total length of each chip</p>	z: Chip thickness	y: Chip width	x: Chip length	$Z \leq 1/2t$	Not over viewing area	$x \leq 1/8a$	$1/2t < z \leq 2t$	Not exceed 1/3k	$x \leq 1/8a$	z: Chip thickness	y: Chip width	x: Chip length	$Z \leq 1/2t$	Not over viewing area	$x \leq 1/8a$	$1/2t < z \leq 2t$	Not exceed 1/3k	$x \leq 1/8a$	2.5
z: Chip thickness	y: Chip width	x: Chip length																			
$Z \leq 1/2t$	Not over viewing area	$x \leq 1/8a$																			
$1/2t < z \leq 2t$	Not exceed 1/3k	$x \leq 1/8a$																			
z: Chip thickness	y: Chip width	x: Chip length																			
$Z \leq 1/2t$	Not over viewing area	$x \leq 1/8a$																			
$1/2t < z \leq 2t$	Not exceed 1/3k	$x \leq 1/8a$																			

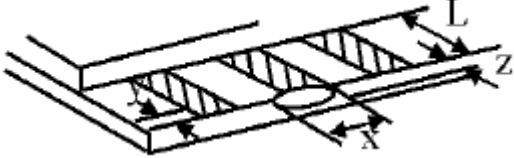
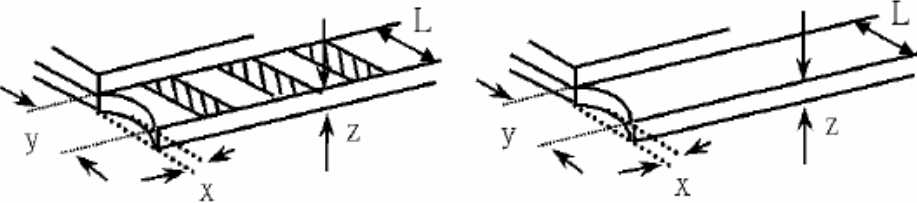
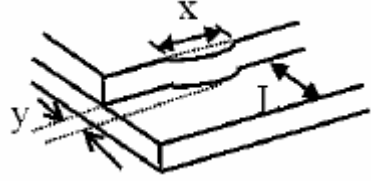
NO	Item	Criterion	AQL																
08	Glass crack	<p>Symbols: x: Chip length y: Chip width z: Chip thickness k: Seal width t: Glass thickness a: LCD side length L: Electrode pad length</p> <p>8.1 Protrusion over terminal: 8.1.1 Chip on electrode pad:</p>  <table border="1" data-bbox="485 685 1171 842"> <tr> <td>y: Chip width</td> <td>x: Chip length</td> <td>z: Chip thickness</td> </tr> <tr> <td>$y \leq 0.5\text{mm}$</td> <td>$x \leq 1/8a$</td> <td>$0 < z \leq t$</td> </tr> </table> <p>8.1.2 Non-conductive portion:</p>  <table border="1" data-bbox="485 1205 1171 1361"> <tr> <td>y: Chip width</td> <td>x: Chip length</td> <td>z: Chip thickness</td> </tr> <tr> <td>$y \leq L$</td> <td>$x \leq 1/8a$</td> <td>$0 < z \leq t$</td> </tr> </table> <p>⊙ If there chipped area touches the ITO terminal, over 2/3 of the ITO must remain and be inspected according to electrode terminal specifications. ⊙ If the product will be heat sealed by the customer, the alignment mark must not be damaged.</p> <p>8.1.3 Substrate protuberance and internal crack</p>  <table border="1" data-bbox="804 1675 1246 1832"> <tr> <td>y: width</td> <td>x: length</td> </tr> <tr> <td>$y \leq 1/3L$</td> <td>$X \leq a$</td> </tr> </table>	y: Chip width	x: Chip length	z: Chip thickness	$y \leq 0.5\text{mm}$	$x \leq 1/8a$	$0 < z \leq t$	y: Chip width	x: Chip length	z: Chip thickness	$y \leq L$	$x \leq 1/8a$	$0 < z \leq t$	y: width	x: length	$y \leq 1/3L$	$X \leq a$	2.5
		y: Chip width	x: Chip length	z: Chip thickness															
		$y \leq 0.5\text{mm}$	$x \leq 1/8a$	$0 < z \leq t$															
y: Chip width	x: Chip length	z: Chip thickness																	
$y \leq L$	$x \leq 1/8a$	$0 < z \leq t$																	
y: width	x: length																		
$y \leq 1/3L$	$X \leq a$																		

NO	Item	Criterion	AQL
09	Cracked glass	The LCD with extensive crack is not acceptable.	2.5
10	Backlight elements	10.1 Illumination source flickers when lit. 10.2 Spots or scratches that appear when lit must be judged. Using LCD spot, lines and contamination standards. 10.3 Backlight doesn't light or color is wrong.	2.5 2.5 0.65
11	Bezel	Bezel must comply with product specifications.	2.5
12	PCB、COB	12.1 COB seal may not have pinholes larger than 0.2mm or contamination. 12.2 COB seal surface may not have pinholes through to the IC. 12.3 The height of the COB should not exceed the height indicated in the assembly diagram. 12.4 There may not be more than 2mm of sealant outside the seal area on PCB. And there should be no more than three places. 12.5 Parts on PCB must be the same as on the production characteristic chart, There should be no wrong parts, missing parts or excess parts. 12.6 The jumper on the PCB should conform to the product characteristic chart.	2.5 2.5 2.5 2.5 0.65 0.65
13	FPC	13.1 FPC terminal damage \leq 1/2 FPC terminal width and can not affect the function , we judge accept. 13.2 FPC alignment hole damage \leq 1/2 alignment area and can not affect the function , we judge accept.	2.5 2.5
14	Soldering	14.1 No cold solder joints, missing solder connections, oxidation or icicle. 14.2 No short circuits in components on PCB or FPC.	2.5 0.65

NO	Item	Criterion	AQL												
15	Touch Panel Chipped glass	<p>Symbols: x: Chip length y: Chip width z: Chip thickness k: Seal width t: Touch Panel Total thickness a: LCD side length L: Electrode pad length</p> <p>15.1 General glass chip: 15.1.1 Chip on panel surface and crack between panels:</p> <table border="1" data-bbox="341 801 1161 1016"> <tr> <td>z: Chip thickness</td> <td>y: Chip width</td> <td>x: Chip length</td> </tr> <tr> <td>$Z \leq t$</td> <td>$\leq 1/2 k$ and not over viewing area</td> <td>$x \leq 1/8a$</td> </tr> </table> <p>⊙ Unit: mm ⊙ If there are 2 or more chips, x is the total length of each chip</p> <p>15.1.2 Corner crack:</p> <table border="1" data-bbox="341 1397 1161 1612"> <tr> <td>z: Chip thickness</td> <td>y: Chip width</td> <td>x: Chip length</td> </tr> <tr> <td>$z \leq t$</td> <td>$\leq 1/2 k$ and not over viewing area</td> <td>$x \leq 1/8a$</td> </tr> </table> <p>⊙ Unit: mm ⊙ If there are 2 or more chips, x is the total length of each chip</p>	z: Chip thickness	y: Chip width	x: Chip length	$Z \leq t$	$\leq 1/2 k$ and not over viewing area	$x \leq 1/8a$	z: Chip thickness	y: Chip width	x: Chip length	$z \leq t$	$\leq 1/2 k$ and not over viewing area	$x \leq 1/8a$	2.5
z: Chip thickness	y: Chip width	x: Chip length													
$Z \leq t$	$\leq 1/2 k$ and not over viewing area	$x \leq 1/8a$													
z: Chip thickness	y: Chip width	x: Chip length													
$z \leq t$	$\leq 1/2 k$ and not over viewing area	$x \leq 1/8a$													

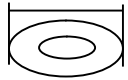
NO	Item	Criterion	AQL	
16	Touch Panel(Fish eye)	SIZE(mm)	Acceptable Q'ty	2.5
		$L \leq 0.7$	Accept no dense	
		$L > 0.7\text{mm}$	0	
				
17	Touch Panel Newton ring	Newton ring dimension $\leq 1/2$ touch panel area and not affect font and line distortion($\leq 2.5\%$), it is acceptable.	2.5	
18	Touch Panel Linearity	Less than 2.5% is acceptable.	2.5	
19	LCD Ripple	Touch the touch panel, can not see the LCD ripple. Pen: R 1.0mm silicon rubber. Operation Force: 80g	2.5	
20	General appearance	20.1 Pin type must match type in specification sheet.	0.65	
		20.2 LCD pin loose or missing pins.	0.65	
		20.3 Product packaging must the same as specified on packaging specification sheet.	0.65	
		20.4 Product dimension and structure must conform to product specification sheet.	0.65	

13. Handling Precaution:

13-1 Handling of LCM

- Don't give external shock.
- Don't apply excessive force on the surface.
- Liquid in LCD is hazardous substance. Must not lick and swallow. when the liquid is attach to your hand, skin, cloth etc. Wash it out thoroughly and immediately.
- Don't operate it above the absolute maximum rating.
- Don't disassemble the LCM.
- The operators should be grounded whenever he/she comes into contact with the module. Never touch any of the conductive parts such as the LSI pads, the copper leads on the PCB and the interface terminals with any parts of the human body.
- The modules should be kept in antistatic bags or other containers resistant to static for storage.
- The module is coated with a film to protect the display surface. Be care when peeling off this protective film since static electricity may be generated.

13-2 Storage

- Store in an ambient temperature of $25\pm 10^{\circ}\text{C}$, and in a relative humidity of $50\pm 10\%\text{RH}$. Don't expose to sunlight or fluorescent light.
- Storage in a clean environment, free from dust, active gas, and solvent.
- Store in anti-static electricity container.
- Store without any physical load.
- Appearance, 3months;Function,1year;within the validity, failed CTP can be replaced 1 to 1

13-3 Soldering

- Use only soldering irons with proper grounding and no leakage.
- Iron: No higher than $280\pm 10^{\circ}\text{C}$ and less than 3 sec during Hand soldering.
- Rewiring: no more than 2 times.

14. Guarantee:

Our products meet requirements of the environment.

YEEBO ROHS requirement is based on European Union Directive 2011/65/EU (ROHS) Requirements and Update.