

Product Specification

(Common Application)

Product Name: VGM096096A7W01

Product Code: M02380

Customer
Approved by Customer
Approved Date:

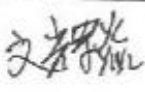
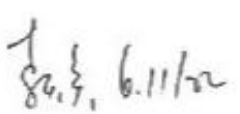
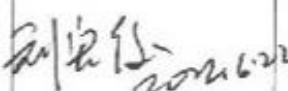
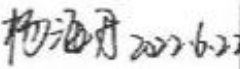
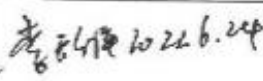
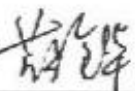
Designed By	Checked By	Approved By	
		R&D	QA
 2022.6.10	 6.11/22	 2022.6.22  2022.6.22	 2022.6.24  2022.6.24

CONTENT

REVISION RECORD	3
1 APPLICATION FILED	4
2 OVERVIEW	4
3 FEATURES	4
4 MECHANICAL DATA	4
5 MECHANICAL DRAWING	5
6 MODULE INTERFACE	6
7 FUNCTION BLOCK DIAGRAM	6
8 ABSOLUTE MAXIMUM RATINGS	7
9 ELECTRICAL CHARACTERISTICS	8
9.1 DC ELECTRICAL CHARACTERISTICS	8
9.2 ELECTRO-OPTICAL CHARACTERISTICS	8
9.3 AC ELECTRICAL CHARACTERISTICS	9
10 FUNCTIONAL SPECIFICATION AND APPLICATION CIRCUIT	10
10.1 POWER ON AND POWER OFF SEQUENCE.....	10
10.2 APPLICATION CIRCUIT.....	11
10.3 DISPLAY CONTROL INSTRUCTION.....	12
10.4 RECOMMENDED SOFTWARE INITIALIZATION	12
11 PACKAGE SPECIFICATION	13
12 RELIABILITY	14
12.1 RELIABILITY TEST.....	14
12.2 LIFETIME.....	14
12.3 FAILURE CHECK STANDARD	14
13 ILLUSTRATION OF OLED PRODUCT NAME	15
14 OUTGOING QUALITY CONTROL SPECIFICATIONS	16
14.1 SAMPLING METHOD	16
14.2 INSPECTION CONDITIONS	16
14.3 QUALITY ASSURANCE ZONES.....	16
14.4 INSPECTION STANDARD.....	17
15 PRECAUTIONS FOR OPERATION AND STORAGE	20
15.1 PRECAUTIONS FOR OPERATION	20
15.2 SOLDERING	20
15.3 PRECAUTIONS FOR STORAGE.....	20
15.4 WARRANTY PERIOD.....	20

1 Application filed

Common Application

2 Overview

VGM096096A7W01 is a monochrome OLED display module with 96×96 dot matrix. The characteristics of this display module are high brightness, self-emission, high contrast ratio, slim/thin outline, wide viewing angle, wide temperature range, and low power consumption.

3 Features

- Display Color: White
- Dot Matrix: 96×96
- Driver IC: SSD1317
- Interface: 4-wire SPI
- Wide range of operating temperature: -40°C to 70°C
- Wide range of Storage temperature: -40°C to 85°C

4 Mechanical Data

NO.	ITEM	SPECIFICATION	UNIT
1	Dot Matrix	96(W)×96(H)	-
2	Dot Size	0.16(W)×0.16(H)	mm ²
3	Dot Pitch	0.18(W)×0.18(H)	mm ²
4	Aperture Rate	79	%
5	Active Area	17.26(W)×17.26(H)	mm ²
6	Panel Size	19.8(W)×23.7(H) ×1.05(T)	mm ³
7	Module Size	19.8(W)×37.5(H) ×1.28(T)	mm ³
8	Diagonal A/A Size	0.96	inch
9	Module Weight	1.04±10%	g

5 Mechanical Drawing

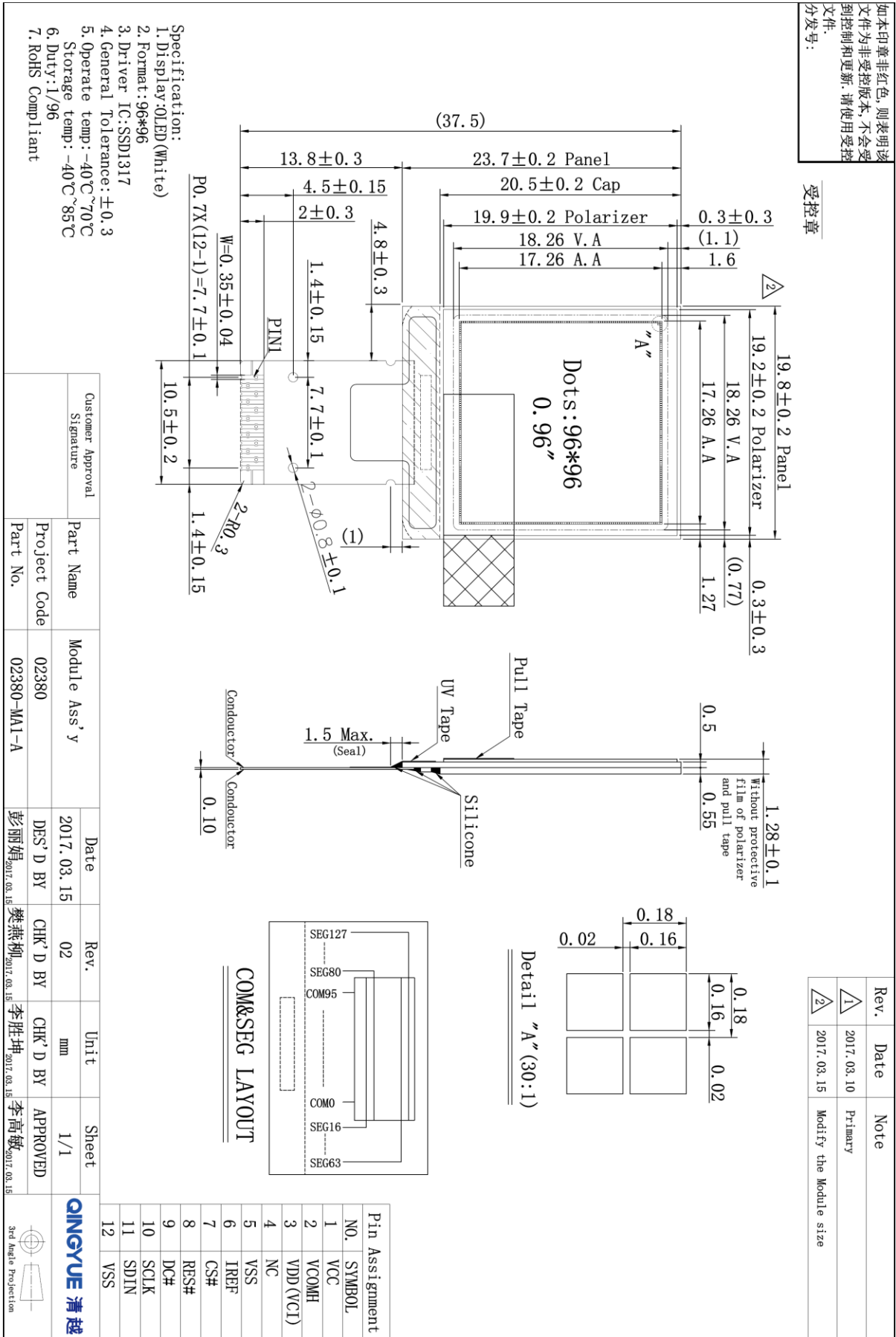

Rev.	Date	Note
1	2017.03.10	Primary
2	2017.03.15	Modify the Module size

6 Module Interface

PIN NO.	PIN NAME	DESCRIPTION
1	VCC	Power supply for panel driving voltage. This is also the most positive power voltage supply pin. It is supplied by external high voltage source.
2	VCOMH	COM signal deselected voltage level. A capacitor should be connected between this pin and VSS. No external power supply is allowed to connect to this pin.
3	VDD(VCI)	Power supply pin for core logic and operation. A capacitor should be connected between VDD and VSS under all circumstances.
4	NC	No connection.
5,12	VSS	This is a ground pin.
6	IREF	This pin is the segment output current reference pin. A resistor should be connected between this pin and VSS to maintain the current around 18.75uA.
7	CS#	This pin is the chip select input connecting to the MCU.
8	RES#	This pin is reset signal input.
9	D/C#	This pin is Data/Command control pin connecting to the MCU.
10	SCLK	When serial interface mode is selected, D0 will be the serial clock input: SCLK; D1 will be the serial data input: SDIN.
11	SDIN	When serial interface mode is selected, D0 will be the serial clock input: SCLK; D1 will be the serial data input: SDIN.

7 Function Block Diagram

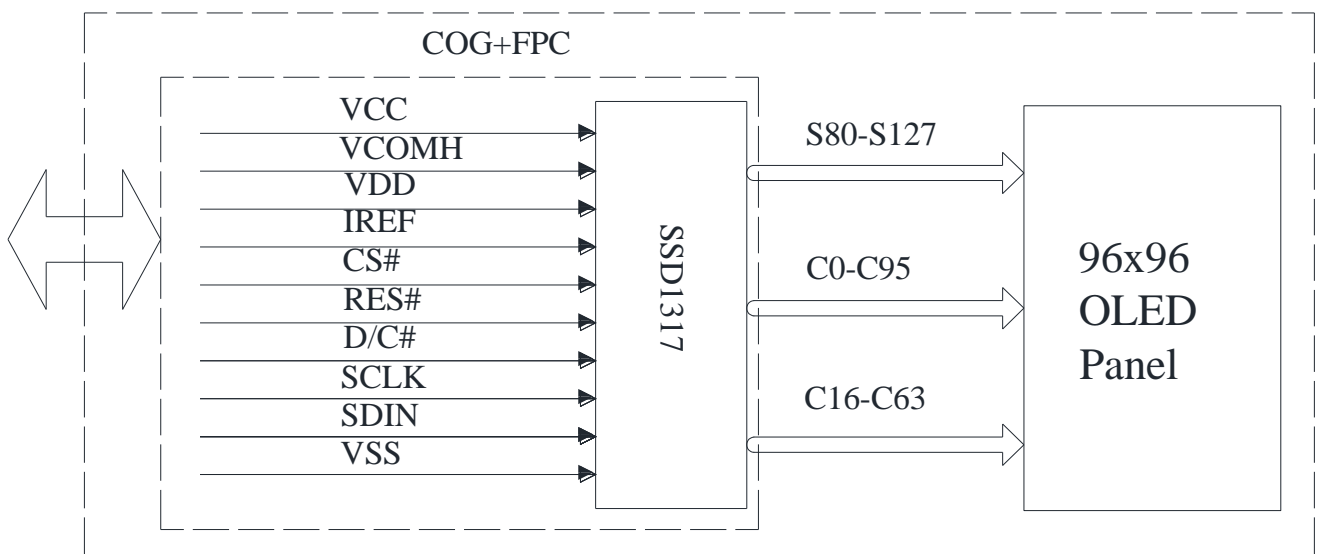

8 Absolute Maximum Ratings

ITEM	SYMBOL	MIN	MAX	UNIT	REMARK
Supply voltage	VDD	-0.3	4.0	V	IC maximum rating
	VCC	-0.5	17.0	V	IC maximum rating
Operating Temp.	Top	-40	70	°C	-
Storage Temp	Tstg	-40	85	°C	-

Note (1): All of the voltages are on the basis of “VSS = 0V”.

Note (2): Permanent breakage of module may occur if the module is used beyond the maximum rating. The module can be normal operated under the conditions according to Section 9 “Electrical Characteristics”. Malfunctioning of the module may occur and the reliability of the module may deteriorate if the module is used beyond the conditions.

9 Electrical Characteristics

9.1 DC Electrical Characteristics

ITEM	SYMBOL	TEST CONDITION	MIN	TYP	MAX	UNIT
Operating Voltage	VCC	-	11.5	12	12.5	V
Logic Supply Voltage	VDD	-	1.65	-	3.5	V
High Logic Output Level	V _{OH}	I _{out} =100uA	0.9×VDD	-	VDD	V
Low Logic Output Level	V _{OL}	I _{out} =100uA	0	-	0.1×VDD	V
High Logic Input Level	V _{IH}	-	0.8×VDD	-	VDD	V
Low Logic Input Level	V _{IL}	-	0	-	0.2×VDD	V

Note: The VCC VDD input must be kept in a stable value; ripple and noise are not allowed.

9.2 Electro-optical Characteristics

ITEM	SYMBOL	TEST CONDITION	MIN	TYPE	MAX	UNIT
Normal Mode Brightness (With Polarizer)	L _{br}	All pixels ON (1)	240	300	-	cd/m ²
Normal Mode Power Consumption	Pt	All pixels ON(1)	-	428.4	535.2	mW
Sleep mode current consumption in VDD	I _{sp}	VCI=2.8V, VCC=OFF VDD(external)=2.5V, Display OFF, No panel attached	-	-	20	uA
Sleep mode current consumption in VCC		VCI=2.8V, VCC=OFF VDD(external)=2.5V, Display OFF, No panel attached	-	-	20	uA
C.I.E(White)	(X)	x,y(CIE1931)	0.25	0.29	0.33	
	(Y)		0.27	0.31	0.35	
Dark Room Contrast	CR		10000:1			
Response Time	-		-	10	-	μs
View Angle	-	-	> 160	-	-	Degree

Note(1): Normal Mode test conditions are as follows:

- Driving voltage: 12.0V
- Contrast setting: 0x9F
- Frame rate: 100Hz
- Duty setting: 1/96

9.3 AC Electrical Characteristics

System buses Write characteristics (For 4 wire SPI)

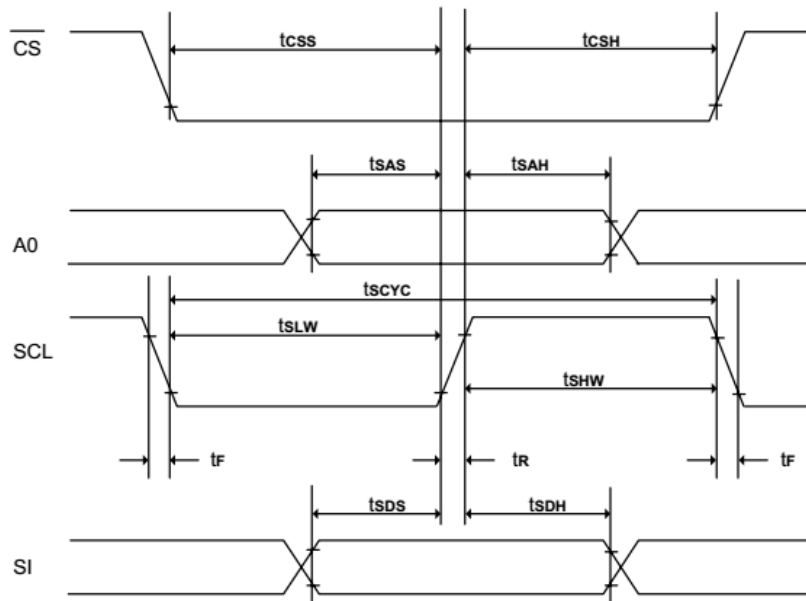

(VDD = 1.65 - 3.5V, TA = +25 °C)

Symbol	Parameter	Min.	Typ.	Max.	Unit	Condition
tSCYC	Serial clock cycle	500	-	-	ns	
tSAS	Address setup time	300	-	-	ns	
tSAH	Address hold time	300	-	-	ns	
tSDS	Data setup time	200	-	-	ns	
tSDH	Data hold time	200	-	-	ns	
tCSS	\overline{CS} setup time	240	-	-	ns	
tCSH	\overline{CS} hold time time	120	-	-	ns	
tSHW	Serial clock H pulse width	200	-	-	ns	
tSLW	Serial clock L pulse width	200	-	-	ns	
tR	Rise time	-	-	30	ns	
tF	Fall time	-	-	30	ns	

(VDD = 2.4 - 3.5V, TA = +25 °C)

Symbol	Parameter	Min.	Typ.	Max.	Unit	Condition
tSCYC	Serial clock cycle	250	-	-	ns	
tSAS	Address setup time	150	-	-	ns	
tSAH	Address hold time	150	-	-	ns	
tSDS	Data setup time	100	-	-	ns	
tSDH	Data hold time	100	-	-	ns	
tCSS	\overline{CS} setup time	120	-	-	ns	
tCSH	\overline{CS} hold time time	60	-	-	ns	
tSHW	Serial clock H pulse width	100	-	-	ns	
tSLW	Serial clock L pulse width	100	-	-	ns	
tR	Rise time	-	-	15	ns	
tF	Fall time	-	-	15	ns	

10 Functional Specification and Application Circuit

10.1 Power ON and Power OFF Sequence

The following figures illustrate the recommended power ON and power OFF sequence of SSD1317 (assume internal VDD is used)

1. Power ON VDD.
2. After VDD become stable, wait at least 20ms (t_0), set RES# pin LOW (logic low) for at least 3 μ s (t_1) (4) and then HIGH (logic high).
3. After set RES# pin LOW (logic low), wait for at least 3 μ s (t_2). Then Power ON VCC.(1)
4. After VCC become stable, send command AFh for display ON. SEG/COM will be ON after 100ms(t_{AF}).

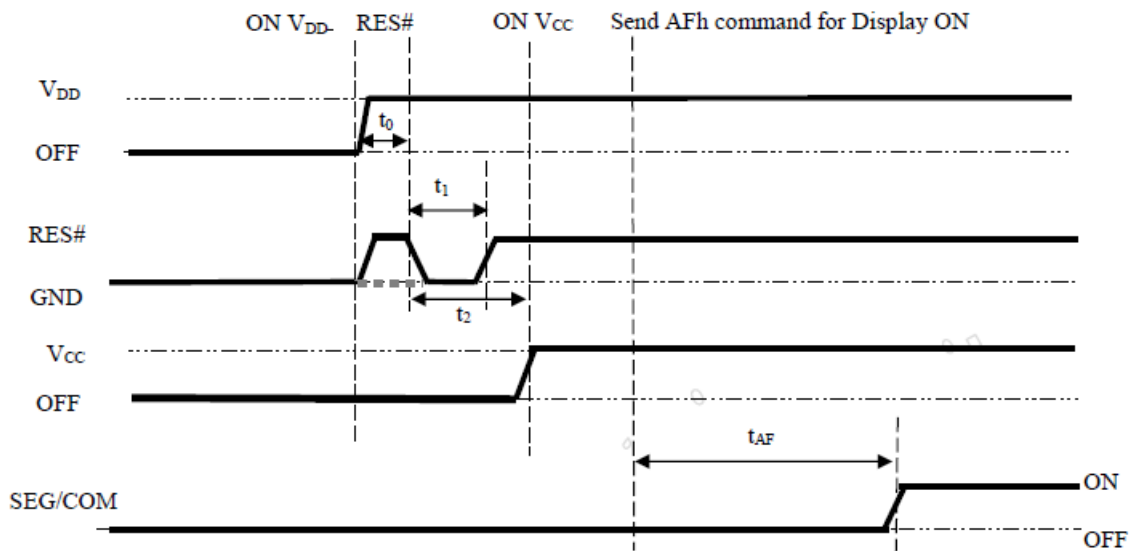

1. Send command AEh for display OFF.
2. Power OFF VCC.(1), (2)
3. Power OFF VDD after t_{OFF} . (4) (where Minimum t_{OFF} =0ms, typical t_{OFF} =100ms)

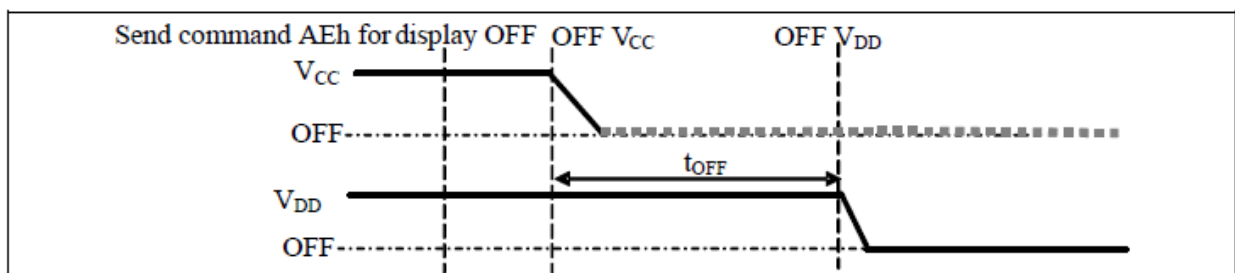

Note:

- (1) VCC should be kept float (i.e. disable) when it is OFF.
- (2) Power Pins (VDD, VCC) can never be pulled to ground under any circumstance.
- (3) The register values are reset after t_1 .
- (4) VDD should not be Power OFF before VCC Power OFF

10.2 Application Circuit

10.2.1 The configuration for 4-wire SPI interface mode is shown in the following diagram:

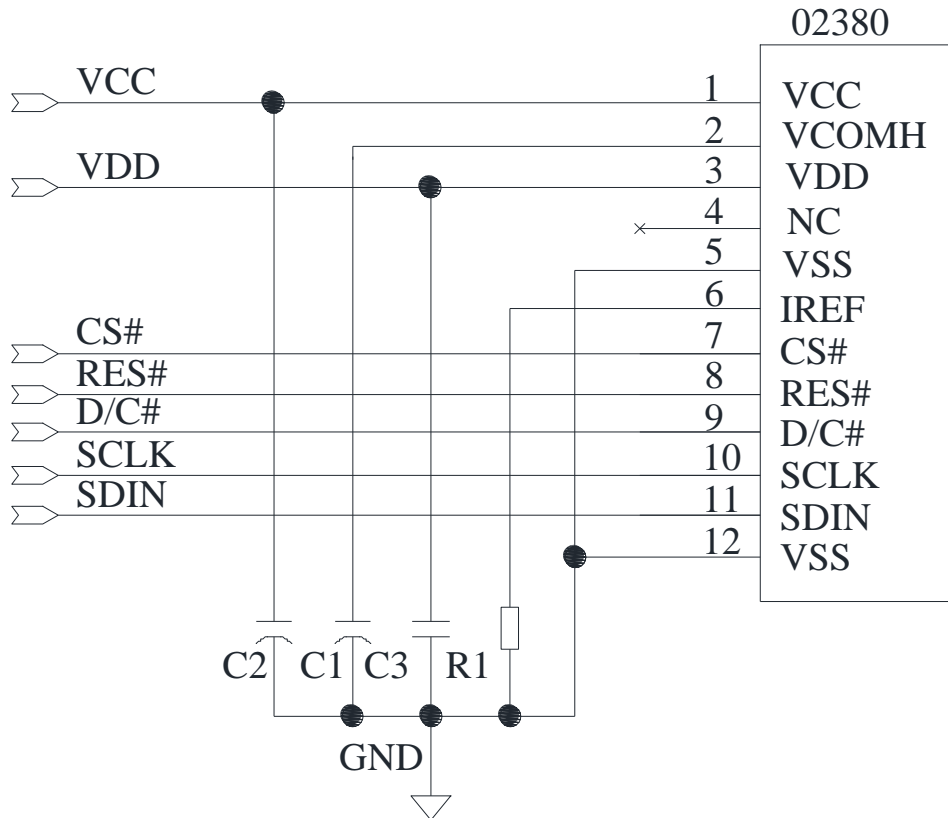

Pin connected to MCU interface: SDIN, SCLK, D/C#, RES#, CS#

Recommended components

C1,C2: 4.7 μ F/25V.RoHS (Tantalum Capacitors)

C3: 0.1 μ F-0603-X7R \pm 10%.RoHS

R1: 0603 1/10W \pm 5% 560 K Ω .RoHS

10.3 Display Control Instruction



Refer to SSD1317 IC Specification.

10.4 Recommended Software Initialization

In order to ensure the reliability and stability of the module, the module must initialize use the following code, Malfunctioning of the module may occur and the reliability of the module may deteriorate if the module is used beyond the initialize code.

```
void Init_IC()
{
    Write_Command(0xAE);    //Set Display Off
    Write_Command(0xD5);    //Display divide ratio/osc. freq. mode
    Write_Command(0xD1);    //
    Write_Command(0xA8);    //Multiplex ratio mode
    Write_Command(0x5F);
    Write_Command(0xD3);    //Set Display Offset
    Write_Command(0x00);
    Write_Command(0xA2);    //Set Display Start Line
    Write_Command(0x00);    //
    Write_Command(0xA0);    //Segment Re-map
    Write_Command(0xC1);    //Set COM Output Scan Direction
    Write_Command(0xDA);    //Common pads hardware: alternative
    Write_Command(0x12);
    Write_Command(0x20);    //Set memory addressing mode
    Write_Command(0x02);    //Page addressing mode
    Write_Command(0xAD);    //Set Select external or internal IREF
    Write_Command(0x00);    //External IREF
    Write_Command(0x81);    //Contrast control
    Write_Command(0x9F);
    Write_Command(0xD9);    //Set pre-charge period
    Write_Command(0x22);
    Write_Command(0xDB);    //VCOM deselect level mode
    Write_Command(0x30);
    Write_Command(0xA4);    //Set Entire Display On/Off
    Write_Command(0xA6);    //Set Normal Display
    Clear_Screen();
    Write_Command(0xAF);    //Set Display On
}
```

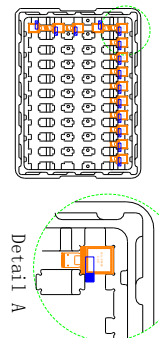
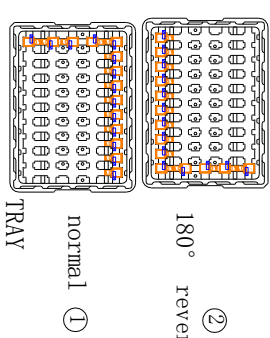
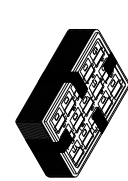
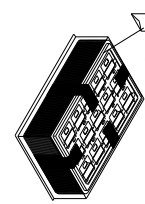
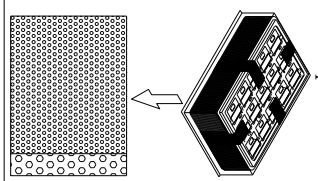
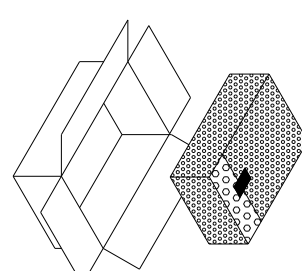
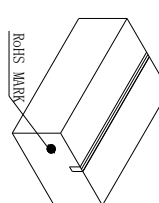
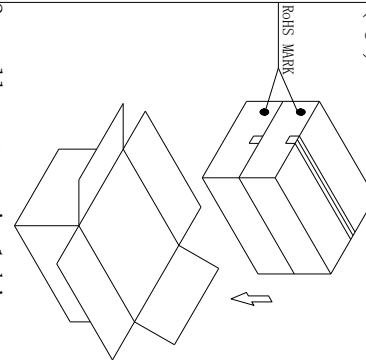
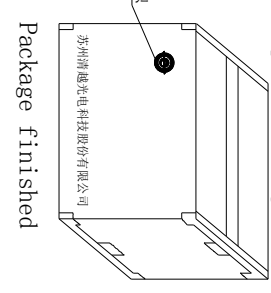
11 Package Specification

Controlled Seal		Packing Process (1)~(9)	
<p>(1) Tray Type:02380-MT5-A Display face up</p> 	<p>(2)</p> 	<p>(3) order ① ② ① ② fix trays with tape 1100 pcs of 1 small carton 1 tray contain 50 pcs 22 contained trays, 1 empty tray</p> 	<p>(4) Use vacuum bag to package the tray and add 5 bags of desiccant into the vacuum bag *5</p> 
<p>(5) After tray be packaged, wrap the package in a bubble bag and seal with scotch tape.</p> 	<p>(6)</p> 	<p>(7)</p> <p>small carton package</p> 	<p>(8)</p> 
<p>(9) 44 contained trays, 2 empty trays, Package quantity products: 2200 pcs of 1 big carton</p>  <p>Package finished</p>	<p>NOTE: 1、The inner carton and master carton must be sealed with adhesive tape. 2、Fill up the gap with tray. 3、If the customer has special needs with the RoHS making, the inner carton and master carton need adhesive new RoHS marking at  . 4、Packaging materials are not recommended for recycling .</p>		

12 Reliability

12.1 Reliability Test

NO.	ITEM	CONDITION	QUANTITY
1	High Temperature (Non-operation)	85°C,240h	5
2	Low Temperature (Non-operation)	-40°C,240h	5
3	High Temperature (Operation)	70°C,240h	5
4	Low Temperature (Operation)	-40°C,240h	5
5	High Temperature / High Humidity (Operation)	60°C,90%RH,240h	5
6	Thermal shock (Non-operation)	-40°C~85°C(-40°C/30min;transit/5min;85°C/30min;transit/5min) 1cycle: 70min,30cycles	5
7	ESD Air discharge (Non-operation)	± 8kV, Test 9 point; Each point discharge 10 times. Time interval is not less than 1 second.	5

Test and measurement conditions

- All measurements shall not be started until the specimens attain to temperature stability, the stable time is at least 15 minutes.
- The degradation of polarizer is ignored for item 5.
- The tolerance of temperature is $\pm 3^{\circ}\text{C}$, and the tolerance of relative humidity is $\pm 5\%$.

Evaluation criteria

- The function test is OK.
- No observable defects.
- Luminance: $\geq 50\%$ of initial value.
- Current consumption: within $\pm 50\%$ of initial value.

12.2 Lifetime

End of lifetime is specified as 50% of initial brightness and the test pattern at operating condition is 50% alternating checkerboard.

ITEM	MIN	MAX	UNIT	CONDITION
Operation Life Time	5000	-	h	300 cd/m ² , 50% alternating checkerboard, 22 \pm 3 °C, 55 \pm 15% RH

12.3 Failure Check Standard

After the completion of the described reliability test, the samples were left at room temperature for 2 hrs prior to conducting the failure test at 22 \pm 3 °C; 55 \pm 15% RH.

13 Illustration of OLED Product Name

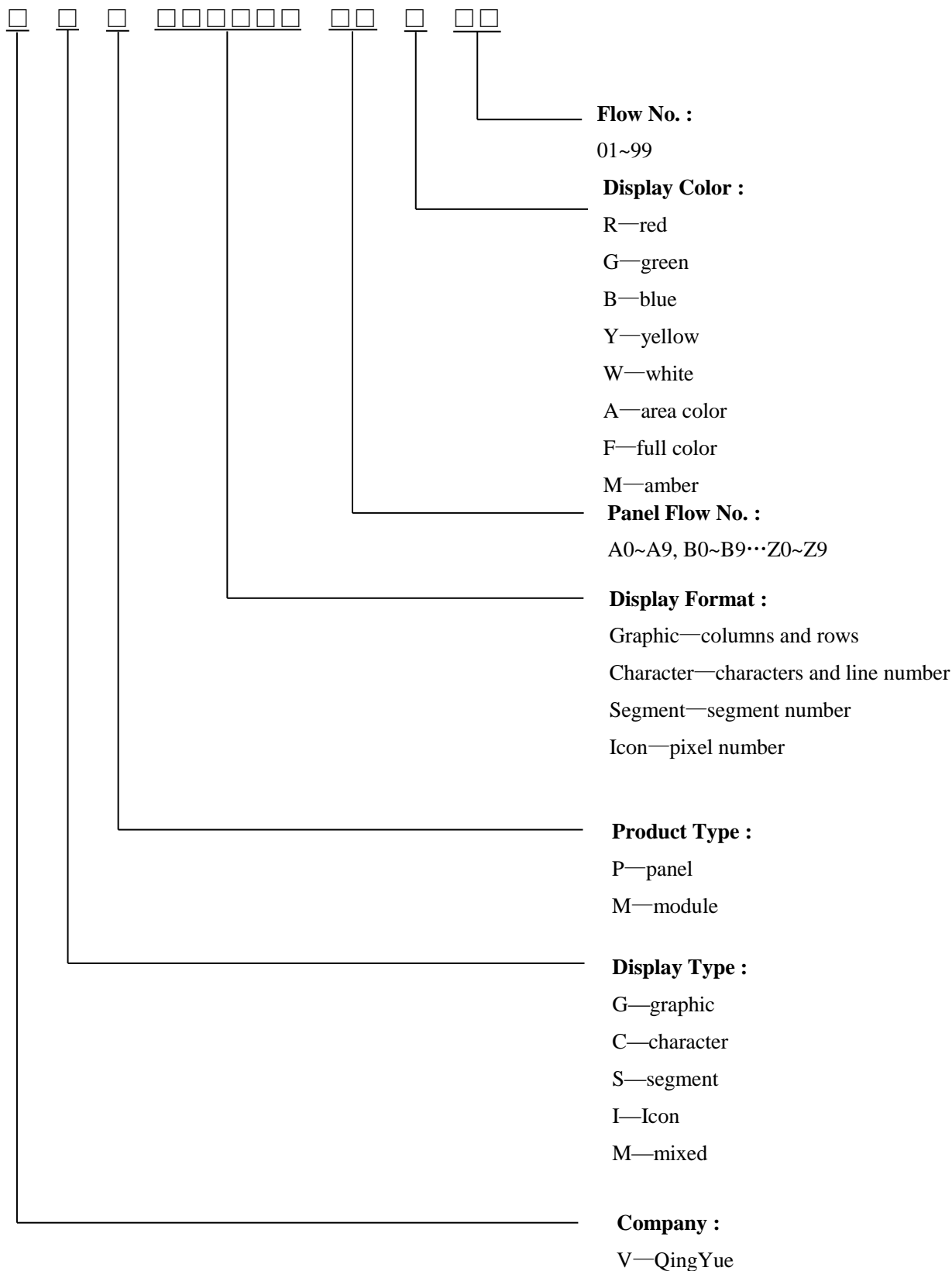

14 Outgoing Quality Control Specifications

14.1 Sampling Method

- (1) GB/T 2828.1/ISO2859-1: inspection level II , normal inspection, single sample inspection
- (2) AQL: Major 0.65; Minor 1.0

14.2 Inspection Conditions

The environmental conditions for test and measurement are performed as follows.

Temperature: $22 \pm 3^{\circ}\text{C}$

Humidity: $55 \pm 15\% \text{R.H}$

Fluorescent Lamp: 30W

Distance between the Panel & Lamp: $\geq 50\text{cm}$

Distance between the Panel & Eyes: $\geq 30\text{cm}$

Viewing angle from the vertical in each direction: $\leq 45^{\circ}$

(See the sketch below)

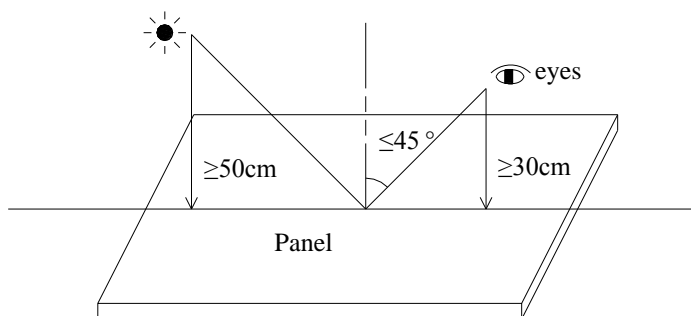

14.3 Quality Assurance Zones

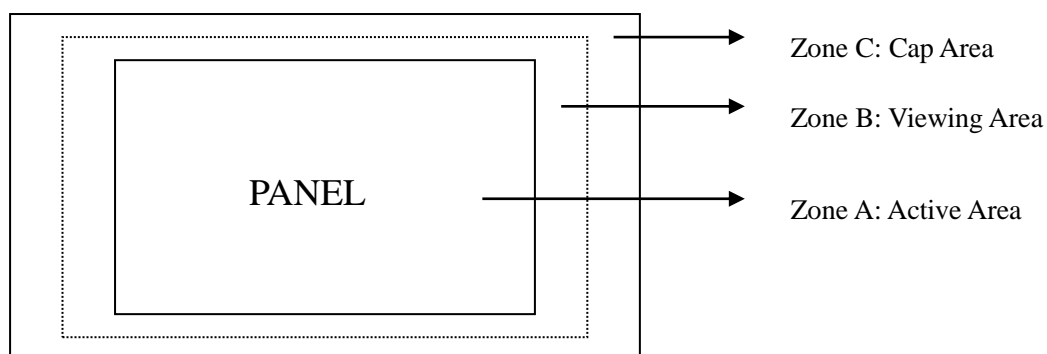

14.4 Inspection Standard

Definition of Φ &L&W (Unit: mm)

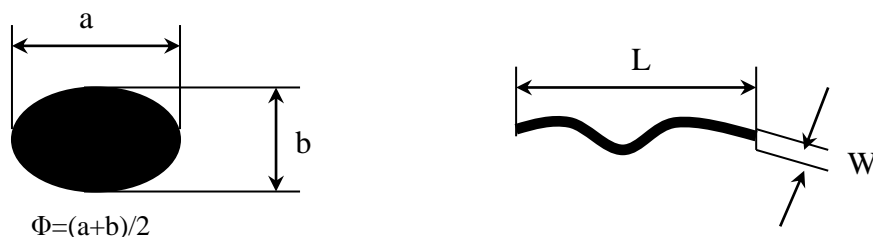

I . Appearance Defects

NO.	ITEM	CRITERIA	CLASSIFICATION																	
1	Polarizer Black or White spot, Dirty spot, Foreign matter, Dent on the polarizer	<table border="1"> <thead> <tr> <th rowspan="2">Average Diameter (mm)</th> <th colspan="2">Acceptable Number</th> </tr> <tr> <th>Zone A,B</th> <th>Zone C</th> </tr> </thead> <tbody> <tr> <td>$\Phi \leq 0.15$</td> <td colspan="2">Ignore</td> </tr> <tr> <td>$0.15 < \Phi \leq 0.30$</td> <td>3</td> <td rowspan="2">Ignore</td> </tr> <tr> <td>$\Phi > 0.30$</td> <td>0</td> </tr> </tbody> </table>	Average Diameter (mm)	Acceptable Number		Zone A,B	Zone C	$\Phi \leq 0.15$	Ignore		$0.15 < \Phi \leq 0.30$	3	Ignore	$\Phi > 0.30$	0	Minor				
Average Diameter (mm)	Acceptable Number																			
	Zone A,B	Zone C																		
$\Phi \leq 0.15$	Ignore																			
$0.15 < \Phi \leq 0.30$	3	Ignore																		
$\Phi > 0.30$	0																			
2	Scratch/line on the glass/Polarizer	<table border="1"> <thead> <tr> <th rowspan="2">Width (mm)</th> <th rowspan="2">Length (mm)</th> <th colspan="2">Acceptable Number</th> </tr> <tr> <th>Zone A,B</th> <th>Zone C</th> </tr> </thead> <tbody> <tr> <td>$W \leq 0.05$</td> <td>---</td> <td colspan="2">Ignore</td> </tr> <tr> <td>$0.05 < W \leq 0.1$</td> <td>$L \leq 5.0$</td> <td>3</td> <td rowspan="2">Ignore</td> </tr> <tr> <td>$W > 0.1$</td> <td>---</td> <td>0</td> </tr> </tbody> </table>	Width (mm)	Length (mm)	Acceptable Number		Zone A,B	Zone C	$W \leq 0.05$	---	Ignore		$0.05 < W \leq 0.1$	$L \leq 5.0$	3	Ignore	$W > 0.1$	---	0	Minor
Width (mm)	Length (mm)	Acceptable Number																		
		Zone A,B	Zone C																	
$W \leq 0.05$	---	Ignore																		
$0.05 < W \leq 0.1$	$L \leq 5.0$	3	Ignore																	
$W > 0.1$	---	0																		
3	Polarizer Bubble	<table border="1"> <thead> <tr> <th rowspan="2">Average Diameter (mm)</th> <th colspan="2">Acceptable Number</th> </tr> <tr> <th>Zone A,B</th> <th>Zone C</th> </tr> </thead> <tbody> <tr> <td>$\Phi \leq 0.2$</td> <td colspan="2">Ignore</td> </tr> <tr> <td>$0.2 < \Phi \leq 0.5$</td> <td>3</td> <td rowspan="2">Ignore</td> </tr> <tr> <td>$\Phi > 0.5$</td> <td>0</td> </tr> </tbody> </table>	Average Diameter (mm)	Acceptable Number		Zone A,B	Zone C	$\Phi \leq 0.2$	Ignore		$0.2 < \Phi \leq 0.5$	3	Ignore	$\Phi > 0.5$	0	Minor				
Average Diameter (mm)	Acceptable Number																			
	Zone A,B	Zone C																		
$\Phi \leq 0.2$	Ignore																			
$0.2 < \Phi \leq 0.5$	3	Ignore																		
$\Phi > 0.5$	0																			
4	Any Dirt & Scratch on Polarizer's Protective Film	Ignore for not affect the polarizer.	Minor																	
5	Any Dirt on Cap Glass	Inside the Cap, Ignore the dirt without moving.	Minor																	

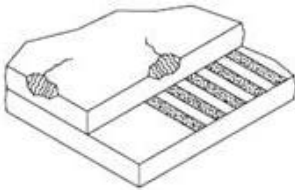
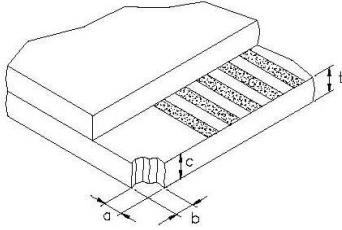
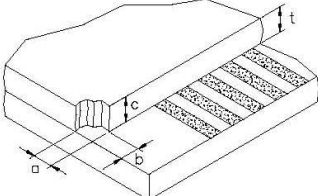
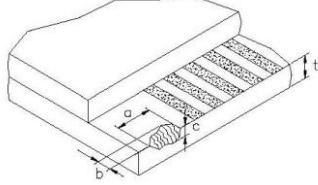
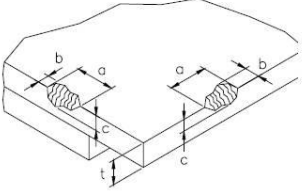
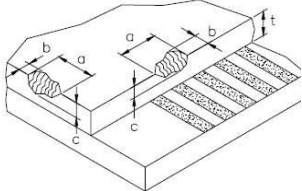
6	Glass Crack	 <p>Propagation crack is not acceptable.</p>	Major
7	Corner Chip	 <p>t= Glass thickness Accept $a \leq 2.0\text{mm}$ or $b \leq 2.0\text{mm}$, $c \leq t$</p>	Minor
8	Corner Chip on Cap Glass	 <p>t= Glass thickness Accept $a \leq 1.5\text{mm}$ or $b \leq 1.5\text{mm}$, $c \leq t$</p>	Minor
9	Chip on Contact Pad	 <p>t= Glass thickness Accept $a \leq 3.0\text{mm}$ or $b \leq 0.8\text{mm}$, $c \leq t$ (on the contact pin) $a \leq 3.0\text{mm}$ or $b \leq 2.0\text{mm}$, $c \leq t$ (outside of the contact pin)</p>	Minor
10	Chip on Face of Display	 <p>t= Glass thickness Accept $a \leq 1.5\text{mm}$ or $b \leq 1.5\text{mm}$, $c \leq t$</p>	Minor
11	Chip on Cap Glass	 <p>t= Glass thickness Accept $a \leq 3.0\text{mm}$ or $b \leq 3.0\text{mm}$, $c \leq t/2$ $a \leq 1.5\text{mm}$ or $b \leq 1.5\text{mm}$, $t/2 \leq c \leq t$</p>	Minor
12	Stain on Surface	Stain removable by soft cloth or air blow is acceptable.	Minor
13	TCP/FPC Damage	<p>(1) Crack, deep scratch, deep hole and deep pressure mark on the TCP/FPC are not acceptable.</p> <p>(2) Terminal lead twisted or broken is not allowable.</p> <p>(3) Copper exposed is not allowed by naked eye inspection.</p>	Minor
14	Dimension Unconformity	Checking by mechanical drawing.	Major

II . Displaying Defects

NO.	Items	Criteria	Classification														
1	Black/White spot Dirty spot Foreign matter	<table border="1"> <thead> <tr> <th>Average Diameter (mm)</th> <th colspan="2">Pieces Permitted</th> </tr> <tr> <td>$\Phi \leq 0.10$</td> <td>Zone A,B</td> <td>Zone C</td> </tr> </thead> <tbody> <tr> <td>$0.10 < \Phi \leq 0.20$</td> <td>Ignore</td> <td rowspan="2">Ignore</td> </tr> <tr> <td>$\Phi > 0.20$</td> <td>3</td> </tr> <tr> <td></td> <td>0</td> <td></td> </tr> </tbody> </table>	Average Diameter (mm)	Pieces Permitted		$\Phi \leq 0.10$	Zone A,B	Zone C	$0.10 < \Phi \leq 0.20$	Ignore	Ignore	$\Phi > 0.20$	3		0		Minor
Average Diameter (mm)	Pieces Permitted																
$\Phi \leq 0.10$	Zone A,B	Zone C															
$0.10 < \Phi \leq 0.20$	Ignore	Ignore															
$\Phi > 0.20$	3																
	0																
2	No Display	Not allowable.	Major														
3	Irregular Display	Not allowable.	Major														
4	Missing Line (row or column)	Not allowable.	Major														
5	Abnormal Color	Refer to the SPEC.	Major														
6	Luminance NG	Refer to the SPEC.	Major														

15 Precautions for operation and Storage

15.1 Precautions for Operation

- (1) Since OLED panel is made of glass, do not apply any mechanical shock or impact or excessive force to it when installing the OLED module. Any strong mechanical impact due to falling dropping etc. may cause damage (breakage or cracking).
- (2) The polarizer on the OLED surface is made of soft material and is easily scratched. Please take most care when handing. When the surface of the polarizer of OLED Module is contaminated, please wipe it off gently by using moisten soft cloth with isopropyl alcohol, do not use water, ketone or aromatics. If there is saliva or water on the OLED surface, please wipe it off immediately.
- (3) When handling OLED module, please be sure that the body and the tools are properly grounded. And do not touch I/O pins with bare hands or contaminate I/O pins, it will cause disconnection or defective insulation of terminals.
- (4) Do not attempt to disassemble or process the OLED module.
- (5) OLED module should be used under recommended operating conditions shown in the specification. Since the higher voltage leads to the shorter lifetime, be sure to use the specified operating voltage.
- (6) Foggy dew, moisture condensation or water droplets deposited on surface and contact terminals will cause polarizer stain or damage, the deteriorated display quality and electrochemical reaction then leads to shorter life time and permanent damage to the module probably. Please pay attention to the environmental temperature and humidity.
- (7) An afterimage is created by the difference in brightness between unused dot and the fixed dot, according to the decrease of brightness of the emitting time. Therefore, to avoid having an afterimage, the full set should be thoroughly used instead of using a fixed dot. When the fixed dot emits, an afterimage can be created.
- (8) Flicker could be come out at full on display. And it disappears when frame frequency increase, but brightness decreases too.

15.2 Soldering

- (1) Soldering should be performed only on the I/O terminals.
- (2) Use soldering irons with proper grounding and no leakage.
- (3) Iron: The temperature setting of electric iron is 350°C, but we suggest that during soldering, the temperature of iron tip should be no higher than 330°C and soldering be finished within 3~4 seconds.

15.3 Precautions for Storage

- (1) Please store OLED module in a dark place. Avoid exposure to sunlight, the light of fluorescent lamp or any ultraviolet ray.
- (2) Keep the environment temperature between 10°C and 35°C and the relative humidity less than 70%. Avoid high temperature and high humidity.
- (3) Keep the OLED modules stored in the container when shipped from supplier before using them is recommended.
- (4) Do not leave any article on the OLED module surface for an extended period of time.

15.4 Warranty period

QingYue warrants for a period of 12 months from the shipping date when stored or used under normal condition. In addition to the failure and quality problems caused by man-made damage and force majeure, we promise to provide maintenance and replacement free of charge during the warranty period. If the warranty period has been exceeded, we need to collect the staff's travel expenses, materials and other related costs.